

IRF5806

HEXFET[®] Power MOSFET

- Ultra Low On-Resistance
- P-Channel MOSFET
- Surface Mount
- Available in Tape & Reel
- Low Gate Charge

V_{DSS}	$R_{DS(on)}$ max	I_D
-20V	86m Ω @ $V_{GS} = -4.5V$	-4.0A
	147m Ω @ $V_{GS} = -2.5V$	-3.0A

Description

These P-channel MOSFETs from International Rectifier utilize advanced processing techniques to achieve the extremely low on-resistance per silicon area. This benefit provides the designer with an extremely efficient device for use in battery and load management applications.

The TSOP-6 package with its customized leadframe produces a HEXFET[®] power MOSFET with $R_{DS(on)}$ 60% less than a similar size SOT-23. This package is ideal for applications where printed circuit board space is at a premium. It's unique thermal design and $R_{DS(on)}$ reduction enables a current-handling increase of nearly 300% compared to the SOT-23.

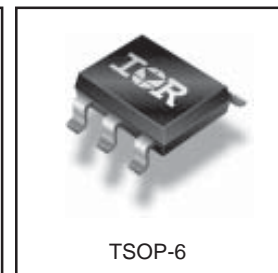
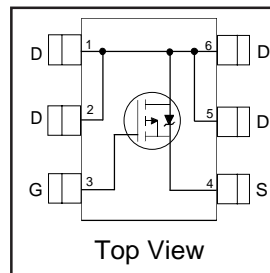

Absolute Maximum Ratings

	Parameter	Max.	Units
V_{DS}	Drain-Source Voltage	-20	V
I_D @ $T_A = 25^\circ\text{C}$	Continuous Drain Current, V_{GS} @ -4.5V	-4.0	A
I_D @ $T_A = 70^\circ\text{C}$	Continuous Drain Current, V_{GS} @ -4.5V	-3.3	
I_{DM}	Pulsed Drain Current ^①	-16.5	
P_D @ $T_A = 25^\circ\text{C}$	Maximum Power Dissipation ^③	2.0	W
P_D @ $T_A = 70^\circ\text{C}$	Maximum Power Dissipation ^③	1.3	W
	Linear Derating Factor	0.02	W/ $^\circ\text{C}$
V_{GS}	Gate-to-Source Voltage	± 20	V
T_J, T_{STG}	Junction and Storage Temperature Range	-55 to + 150	$^\circ\text{C}$

Thermal Resistance

	Parameter	Max.	Units
$R_{\theta JA}$	Maximum Junction-to-Ambient ^③	62.5	$^\circ\text{C}/\text{W}$

Electrical Characteristics @ $T_J = 25^\circ\text{C}$ (unless otherwise specified)

	Parameter	Min.	Typ.	Max.	Units	Conditions
$V_{(BR)DSS}$	Drain-to-Source Breakdown Voltage	-20	—	—	V	$V_{GS} = 0V, I_D = -250\mu A$
$\Delta V_{(BR)DSS}/\Delta T_J$	Breakdown Voltage Temp. Coefficient	—	0.011	—	V/°C	Reference to $25^\circ\text{C}, I_D = -1\text{mA}$
$R_{DS(on)}$	Static Drain-to-Source On-Resistance	—	47.1	86	m Ω	$V_{GS} = -4.5V, I_D = -4.0A$ ②
		—	67.5	147		$V_{GS} = -2.5V, I_D = -3.0A$ ②
$V_{GS(th)}$	Gate Threshold Voltage	-0.45	—	-1.2	V	$V_{DS} = V_{GS}, I_D = -250\mu A$
g_{fs}	Forward Transconductance	6.4	—	—	S	$V_{DS} = -10V, I_D = -4.0A$
I_{DSS}	Drain-to-Source Leakage Current	—	—	-15	μA	$V_{DS} = -16V, V_{GS} = 0V$
		—	—	-25		$V_{DS} = -16V, V_{GS} = 0V, T_J = 70^\circ\text{C}$
I_{GSS}	Gate-to-Source Forward Leakage	—	—	-100	nA	$V_{GS} = -12V$
	Gate-to-Source Reverse Leakage	—	—	100		$V_{GS} = 12V$
Q_g	Total Gate Charge	—	8.3	11.4	nC	$I_D = -4.0A$
Q_{gs}	Gate-to-Source Charge	—	1.2	—		$V_{DS} = -16V$
Q_{gd}	Gate-to-Drain ("Miller") Charge	—	2.6	—		$V_{GS} = -4.5V$
$t_{d(on)}$	Turn-On Delay Time	—	6.2	9.3	ns	$V_{DD} = -10V, V_{GS} = -4.5V$
t_r	Rise Time	—	27	41		$I_D = -1.0A$
$t_{d(off)}$	Turn-Off Delay Time	—	94	140		$R_G = 6.0\Omega$
t_f	Fall Time	—	126	190		$R_D = 10\Omega$ ②
C_{iss}	Input Capacitance	—	594	—	pF	$V_{GS} = 0V$
C_{oss}	Output Capacitance	—	114	—		$V_{DS} = -15V$
C_{rss}	Reverse Transfer Capacitance	—	87	—		$f = 1.0\text{MHz}$

Source-Drain Ratings and Characteristics

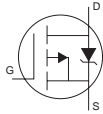
	Parameter	Min.	Typ.	Max.	Units	Conditions
I_S	Continuous Source Current (Body Diode)	—	—	-2.0	A	MOSFET symbol showing the integral reverse p-n junction diode. 
I_{SM}	Pulsed Source Current (Body Diode) ①	—	—	-16.5		
V_{SD}	Diode Forward Voltage	—	—	-1.2	V	$T_J = 25^\circ\text{C}, I_S = -2.0A, V_{GS} = 0V$ ②
t_{rr}	Reverse Recovery Time	—	116	174	ns	$T_J = 25^\circ\text{C}, I_F = -2.0A$
Q_{rr}	Reverse Recovery Charge	—	90	135	nC	$di/dt = -100A/\mu s$ ②

Notes:

① Repetitive rating; pulse width limited by max. junction temperature.

② Pulse width $\leq 300\mu s$; duty cycle $\leq 2\%$.

③ When mounted on 1 inch square Copper board, $t \leq 10\text{sec}$.

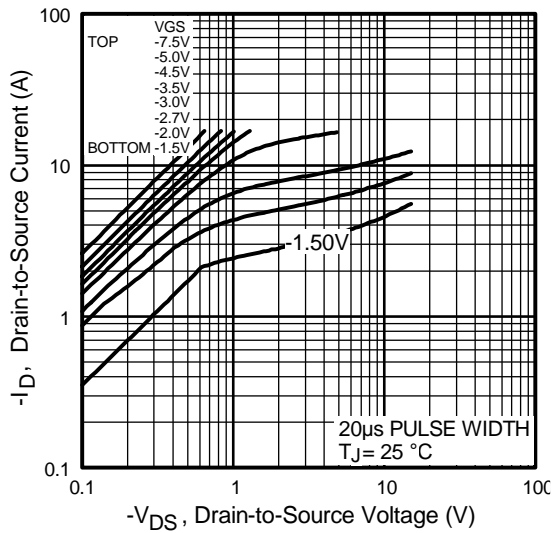

Fig 1. Typical Output Characteristics

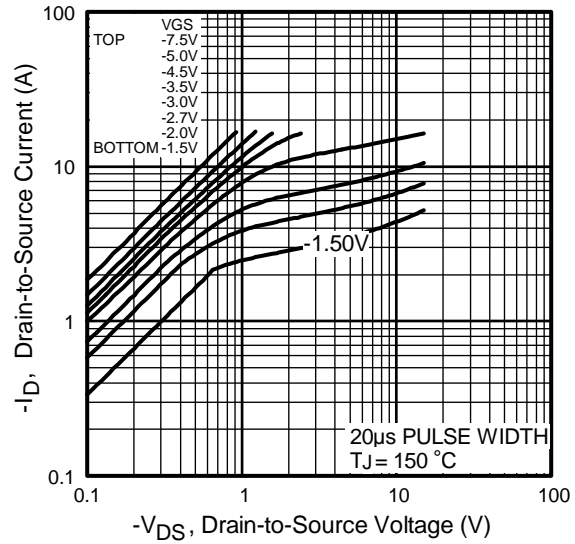

Fig 2. Typical Output Characteristics

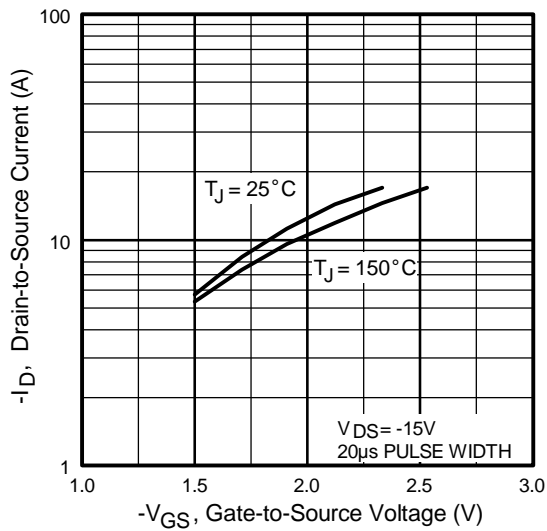

Fig 3. Typical Transfer Characteristics

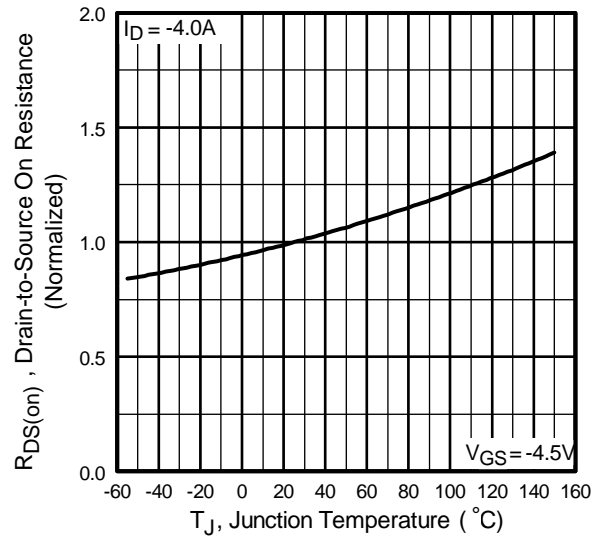

Fig 4. Normalized On-Resistance Vs. Temperature

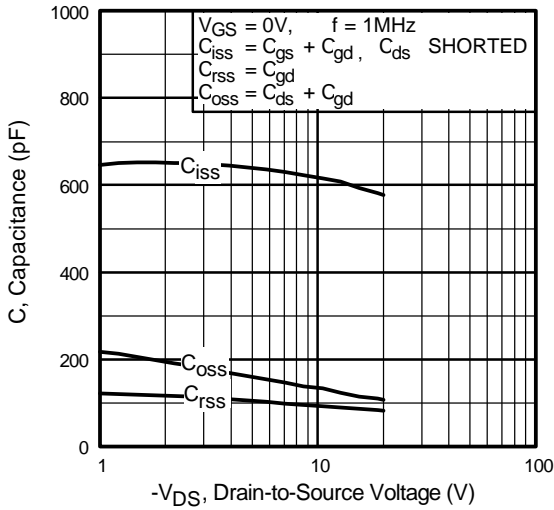

Fig 5. Typical Capacitance Vs. Drain-to-Source Voltage

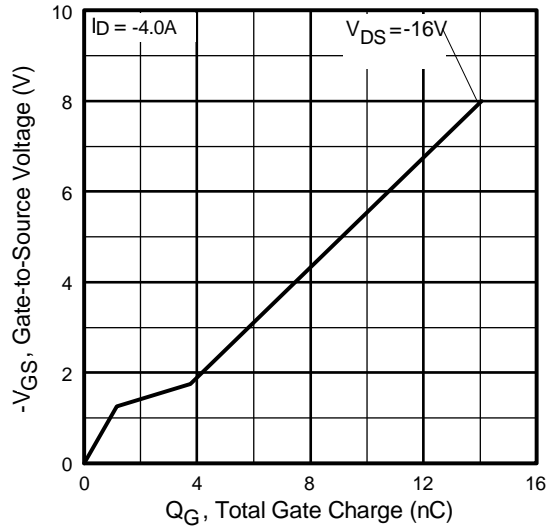

Fig 6. Typical Gate Charge Vs. Gate-to-Source Voltage

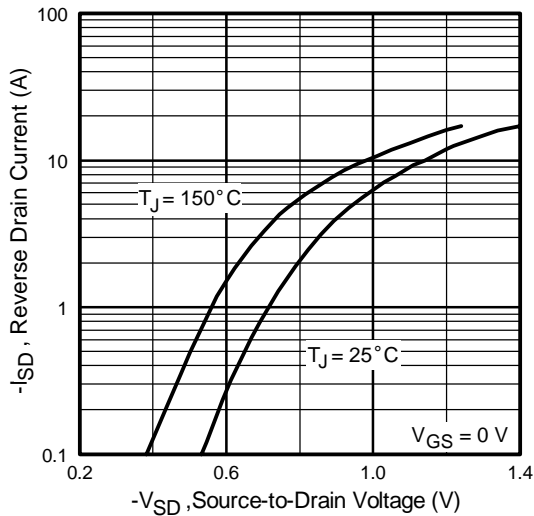

Fig 7. Typical Source-Drain Diode Forward Voltage

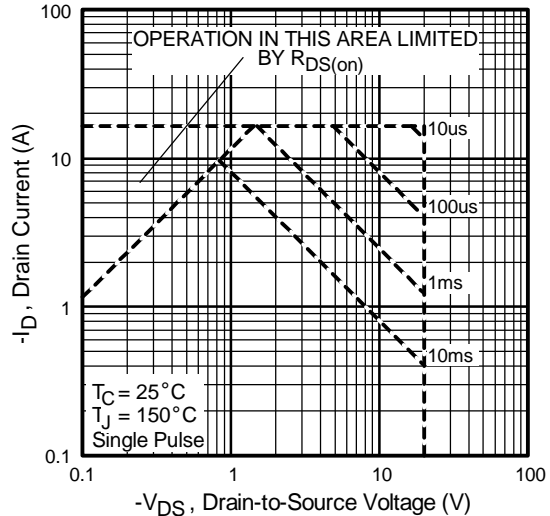

Fig 8. Maximum Safe Operating Area

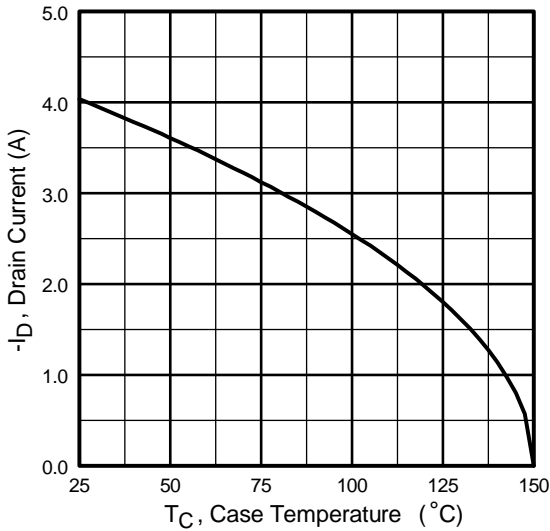

Fig 9. Maximum Drain Current Vs. Case Temperature

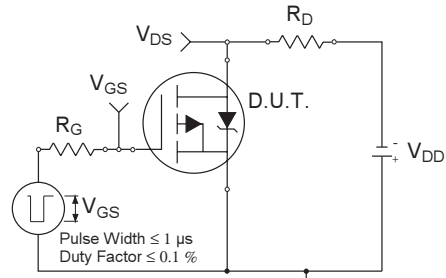

Fig 10a. Switching Time Test Circuit

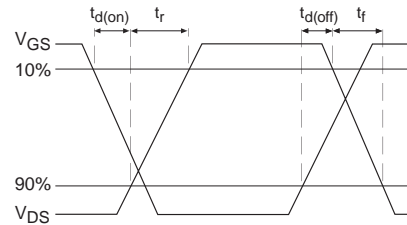

Fig 10b. Switching Time Waveforms

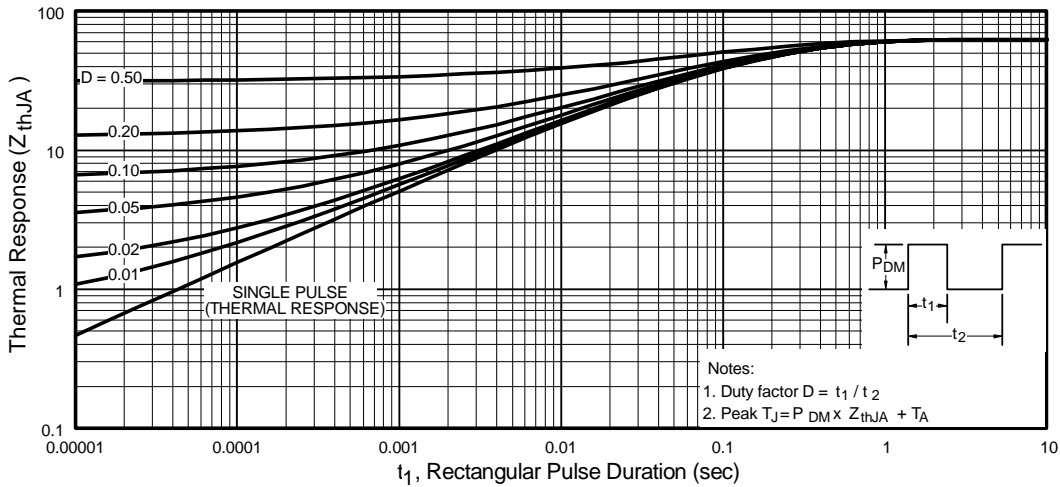

Fig 11. Maximum Effective Transient Thermal Impedance, Junction-to-Ambient

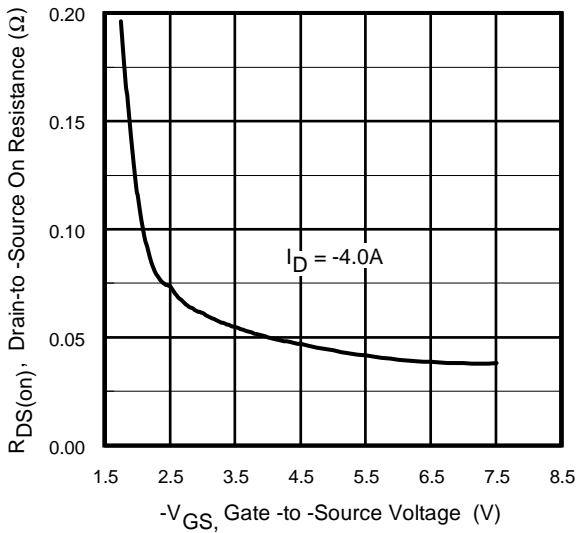

Fig 12. Typical On-Resistance Vs. Gate Voltage

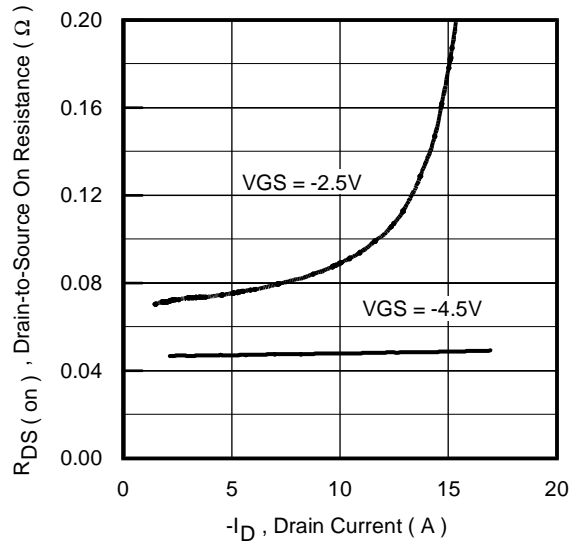

Fig 13. Typical On-Resistance Vs. Drain Current

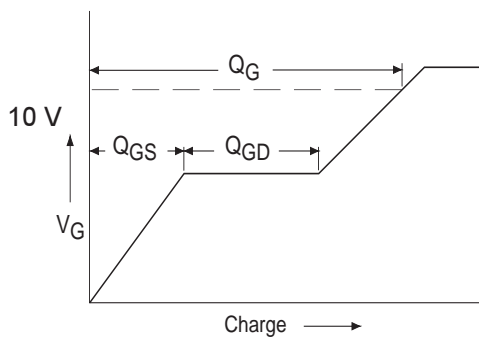

Fig 14a. Basic Gate Charge Waveform

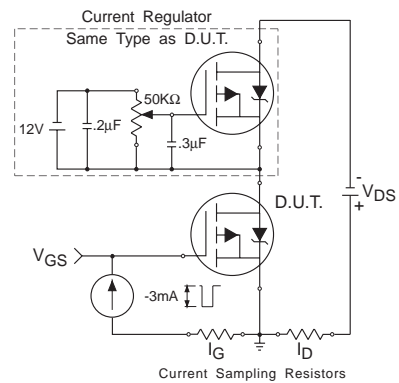

Fig 14b. Gate Charge Test Circuit

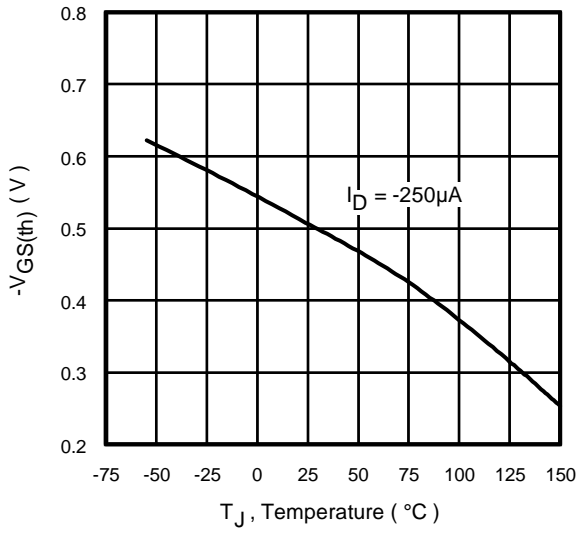

Fig 15. Typical $V_{GS(th)}$ Vs. Junction Temperature

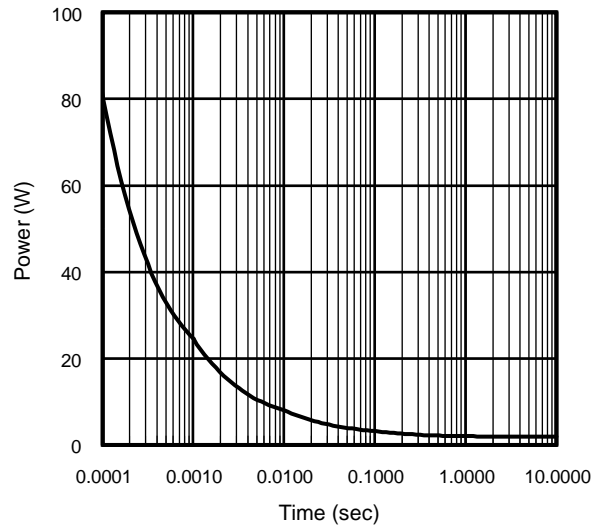
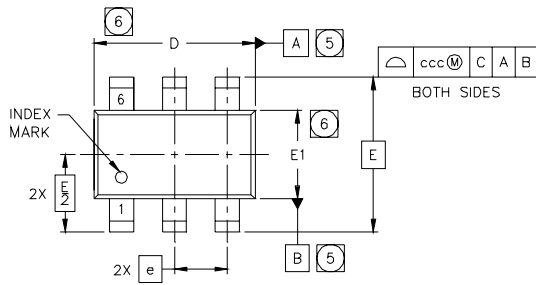

Fig 16. Typical Power Vs. Time

IRF5806

International
IR Rectifier

TSOP-6 Package Outline



SYMBOL	MO-193AA DIMENSIONS					
	MILLIMETERS			INCHES		
	MIN	NOM	MAX	MIN	NOM	MAX
A	---	---	1.10	---	---	.0433
A1	0.01	---	0.10	.0004	---	.0039
A2	0.80	0.90	1.00	.0315	.0354	.0393
b	0.25	---	0.50	.0099	---	.0196
c	0.10	---	0.26	.004	---	.010
D	2.90	3.00	3.10	.115	.118	.122
E	2.75 BSC			.108 BSC		
E1	1.30	1.50	1.70	.052	.059	.066
e	1.00 BSC			.039 BSC		
L	0.20	0.40	0.60	.0079	.0157	.0236
L1	0.30 BSC			.0118 BSC		
θ	0°	---	8°	0°	---	8°
aaa	0.10			.004		
bbb	0.15			.006		
ccc	0.25			.010		

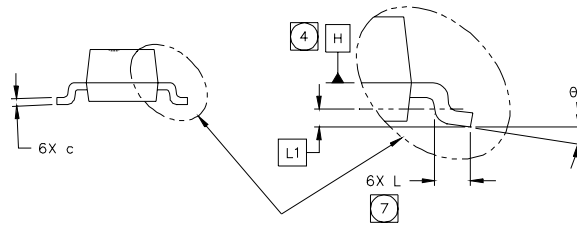
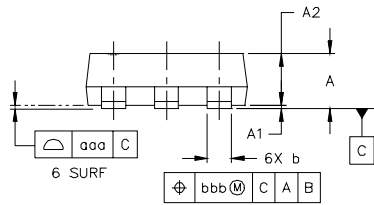

TSOP-6 Tape & Reel Information

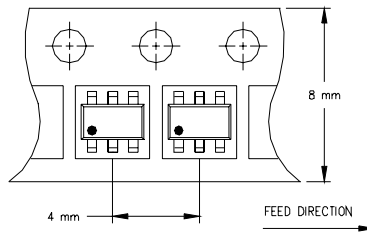

NOTES:
1. OUTLINE CONFORMS TO EIA-481 & EIA-541.

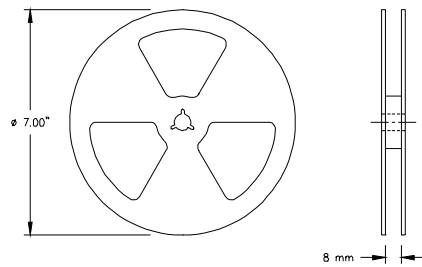

NOTES:
1. OUTLINE CONFORMS TO EIA-481 & EIA-541.

TSOP-6 Part Marking Information

Notes: This part marking information applies to devices produced before 02/26/2001

EXAMPLE: THIS IS AN SI3443DV

WW = (1-26) IF PRECEDED BY LAST DIGIT OF CALENDAR YEAR

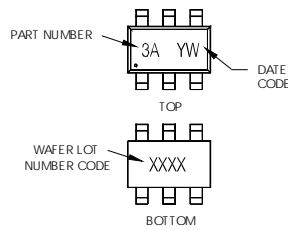

YEAR	Y	WORK WEEK	W
2001	1	01	A
2002	2	02	B
2003	3	03	C
2004	4	04	D
2005	5		
1996	6		
1997	7		
1998	8		
1999	9		
2000	0	24	X
		25	Y
		26	Z

PART NUMBER CODE REFERENCE:

3A = SI3443DV
 3B = IRF5800
 3C = IRF5850
 3D = IRF5851
 3E = IRF5852
 3I = IRF5805
 3J = IRF5806

DATE CODE EXAMPLES:

YYW = 9603 = 6C
 YYW = 9632 = FF

WW = (27-52) IF PRECEDED BY A LETTER

YEAR	Y	WORK WEEK	W
2001	A	27	A
2002	B	28	B
2003	C	29	C
2004	D	30	D
2005	E		
1996	F		
1997	G		
1998	H		
1999	J		
2000	K	50	X
		51	Y
		52	Z

Notes: This part marking information applies to devices produced after 02/26/2001

W = (1-26) IF PRECEDED BY LAST DIGIT OF CALENDAR YEAR

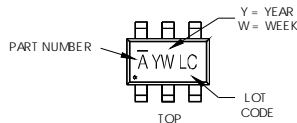

YEAR	Y	WORK WEEK	W
2001	1	01	A
2002	2	02	B
2003	3	03	C
2004	4	04	D
2005	5		
1996	6		
1997	7		
1998	8		
1999	9		
2000	0	24	X
		25	Y
		26	Z

PART NUMBER CODE REFERENCE:

A = SI3443DV
 B = IRF5800
 C = IRF5850
 D = IRF5851
 E = IRF5852
 I = IRF5805
 J = IRF5806
 K = IRF5810
 L = IRF5804
 M = IRF5803
 N = IRF5820

W = (27-52) IF PRECEDED BY A LETTER

YEAR	Y	WORK WEEK	W
2001	A	27	A
2002	B	28	B
2003	C	29	C
2004	D	30	D
2005	E		
1996	F		
1997	G		
1998	H		
1999	J		
2000	K	50	X
		51	Y
		52	Z